

MARKETS

GOVERNANCE DESIGN TEAM

JANUARY 31, 2022



*Working together to responsibly and economically
keep the lights on today and in the future.*



SouthwestPowerPool



SPPorg



southwest-power-pool



Southwest Power Pool
**WESTERN
ENERGY
SERVICES**

WELCOME AND OVERVIEW

KARA FORNSTROM

AGENDA

Welcome and Overview	Kara Fornstrom
Overview <ul style="list-style-type: none">• Stakeholder Process• Development of Milestones/Objectives• Operational Relationships• Foundational Components	Kara Fornstrom Dustin Smith Kara Fornstrom
Operational Relationships <ul style="list-style-type: none">• What Are We Governing• How Does Markets+ Fit: RC	Bruce Rew
Next Steps	Bruce Rew
Open Discussion/Questions	Kara Fornstrom
Future Meetings	Kara Fornstrom

GOVERNANCE DESIGN TEAM

KARA FORNSTROM

STAKEHOLDER LEADS

Sarah Edmonds	Director, Transmission Services	Portland General Electric
Aly Koslow	Director, Federal Regulatory Affairs and Compliance	Arizona Public Service
David Rubin	Federal Energy Policy Director	NV Energy
Joe Fina	Assistant General Counsel	Snohomish County Public Utility District No. 1
Lea Fisher	Senior Policy Analyst	Public Generating Pool

SPP Support Team

Kara Fornstrom	Director, State Regulatory Policy
Mike Riley	Associate General Counsel
Nicole Wagner	Manager, Regulatory Policy
Patti Kelly	Lead Regulatory Analyst

GOVERNANCE DESIGN TEAM

- Meeting Cadence:
 - Beginning Jan. 31, every other Monday
 - Starting at 10 a.m. Pacific, 11 a.m. Mountain, Noon Central
- Initial Topics
 - Operational
 - What are we governing?
 - How does Markets+ fit in with other Western services?
 - Foundational
 - SPP board of directors

OVERVIEW: SPP STAKEHOLDER PROCESS

DUSTIN SMITH



Board of directors approves western RTO expansion terms and conditions.

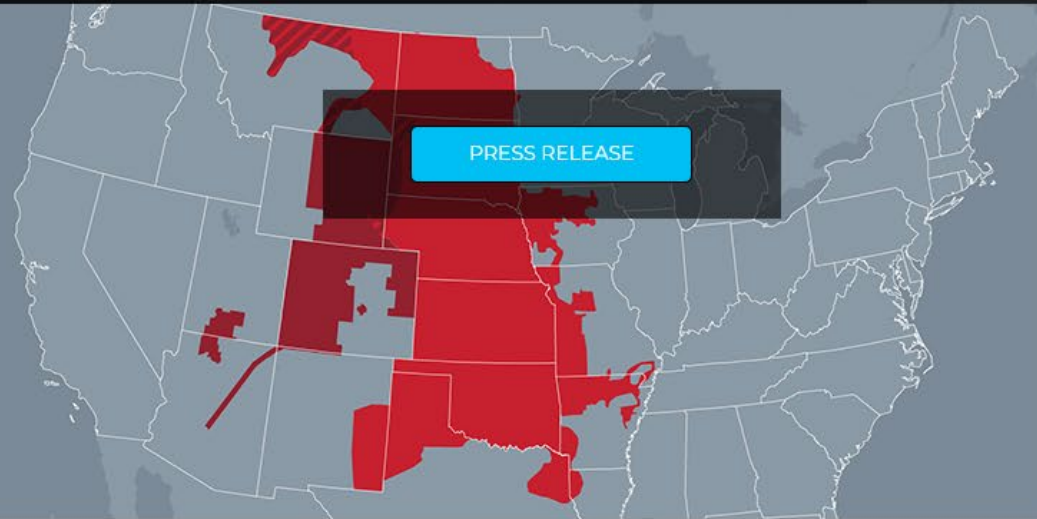

Working together to responsibly and economically keep the lights on today and in the future.

Price Contour Map

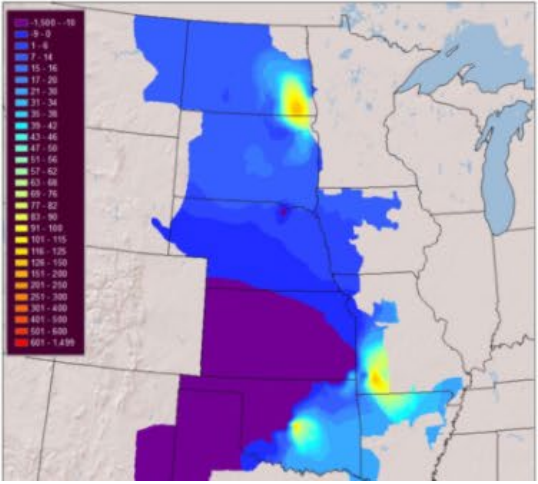

Generation Mix

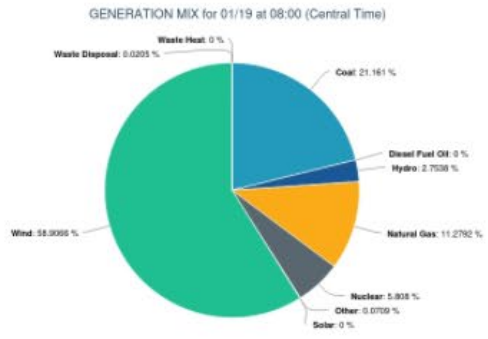

SEE MORE

Forecast vs. Actual

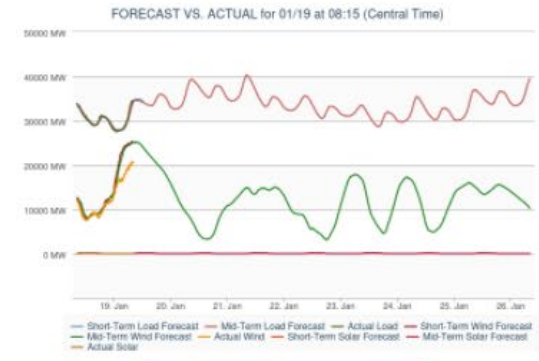

SEE MORE

STAKEHOLDER GROUPS

Select a committee, working group or task force listed below to view a complete summary. Each page contains an overview, roster and related documents. The [SPP Group Organizational Chart](#) lists SPP's groups and their respective chairs and secretaries.

To keep updated about SPP organizational group activities, subscribe to [The Org Report](#), a monthly e-newsletter that summarizes the groups' key activities. To subscribe, visit our [Exploder page](#), fill in the blanks and select Organizational Group E-Newsletter.

[ORGANIZATIONAL GROUPS](#) >

[ADVISORY GROUPS](#) >

[USER FORUMS](#) >

WESTERN ENERGY SERVICES STAKEHOLDER GROUPS ▼

- [Enhanced Curtailment Calculator Working Group](#)
- [Markets+ Development](#)
 - [Markets+ Governance Design Team](#)
 - [Markets+ Market Products and Price Formation Design Team](#)
 - [Markets+ Transmission Availability Design Team](#)
- [Qualified Owners and Operators](#)
 - [Unscheduled Flow Committee](#)
- [Western Markets Executive Committee](#)
 - [Western Markets Working Group](#)

STAKEHOLDER GROUPS

[ORGANIZATIONAL GROUPS](#) >

[ADVISORY GROUPS](#) >

[USER FORUMS](#) >

[WESTERN ENERGY SERVICES STAKEHOLDER GROUPS](#) >

[RETIRED GROUPS](#) >

MARKETS+ GOVERNANCE DESIGN TEAM

Markets+ Governance Design Team

Upcoming Events

[VIEW ALL](#)

Markets+ Governance Design Session

LOCATION:

TIME: April 04, 2022 12:00PM - 1:30PM

REGISTER:

Attending Through:

Markets+ Governance Design Session

LOCATION:

TIME: April 18, 2022 12:00PM - 1:30PM

REGISTER:

Attending Through:

Document Groups



Markets+ Governance
Design Team
Documents

QUICK LINKS

[ORGANIZATIONAL GROUPS](#) >

[ADVISORY GROUPS](#) >

[USER FORUMS](#) >

[WESTERN ENERGY SERVICES STAKEHOLDER GROUPS](#) >

- Enhanced Curtailment Calculator Working Group
- **Markets+ Development**
 - **Markets+ Governance Design Team**
 - Markets+ Market Design Team
 - Markets+ Transmission Design Team
- Qualified Owners and Operators
- Western Markets Executive Committee
- Western Reliability Executive Committee

[RETIRED GROUPS](#) >

SPP board of directors approves **western RTO expansion** terms and conditions.

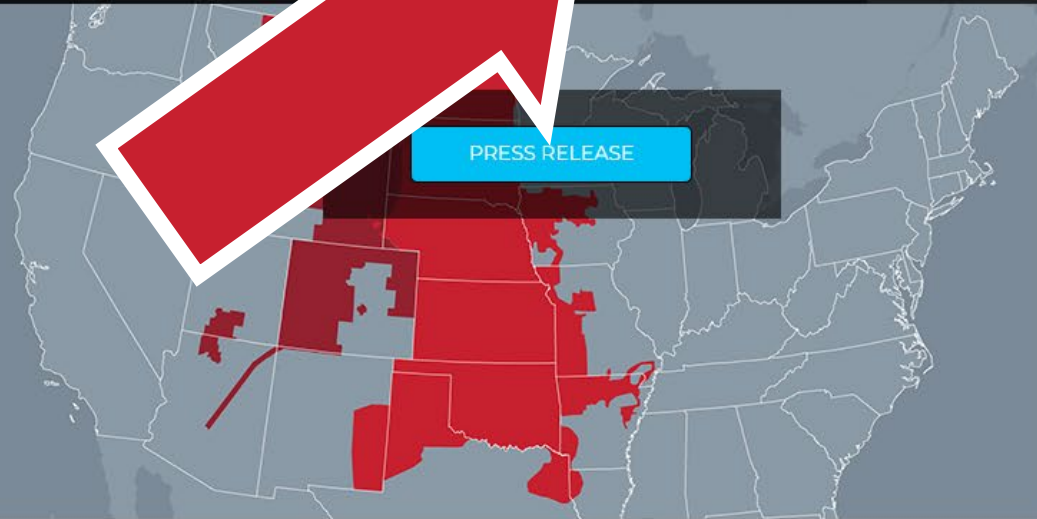

Working together to responsibly and economically keep the lights on today and in the future.

Price Contour Map

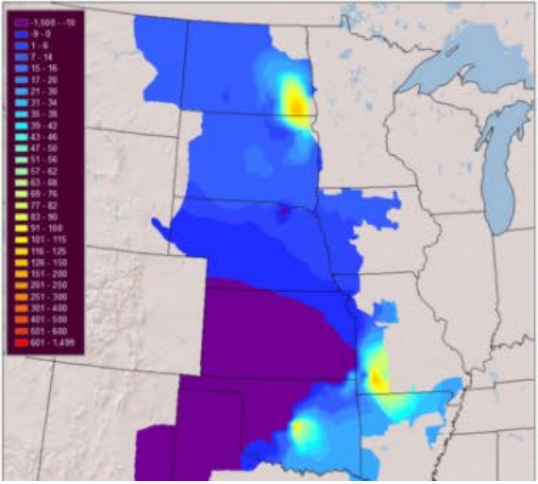

Generation Mix

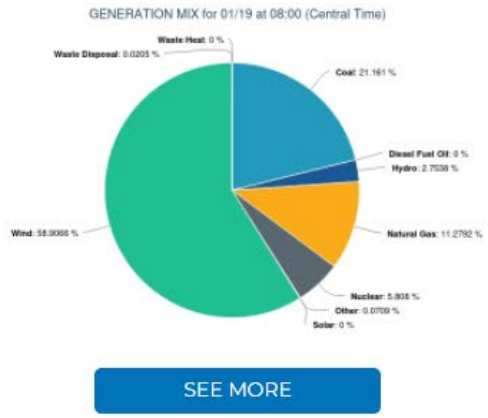

Forecast vs. Actual

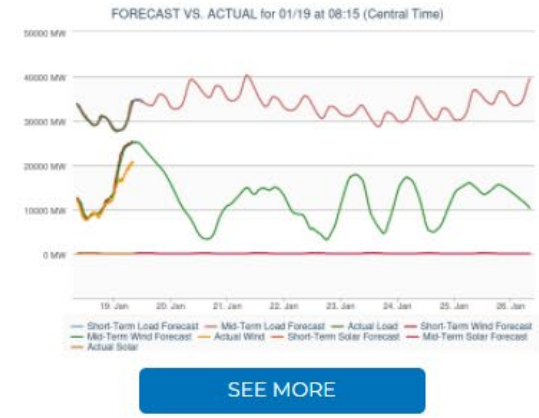

CREATE AN ACCOUNT

To register for events, fill out the form below:

Dietary Restrictions:
 Vegetarian
 Vegan
 Gluten-Intolerant
 Shellfish
 Fish
 Egg
 Milk
 Nut
 Other

OVERVIEW:

- Development of Milestones/Objectives
- Operational Relationships
- Foundational Components

KARA FORNSTROM

OPERATIONAL RELATIONSHIPS

BRUCE REW

SENIOR VICE PRESIDENT, OPERATIONS

OPTIONS FOR EVOLVING WESTERN MARKETS

Current path?

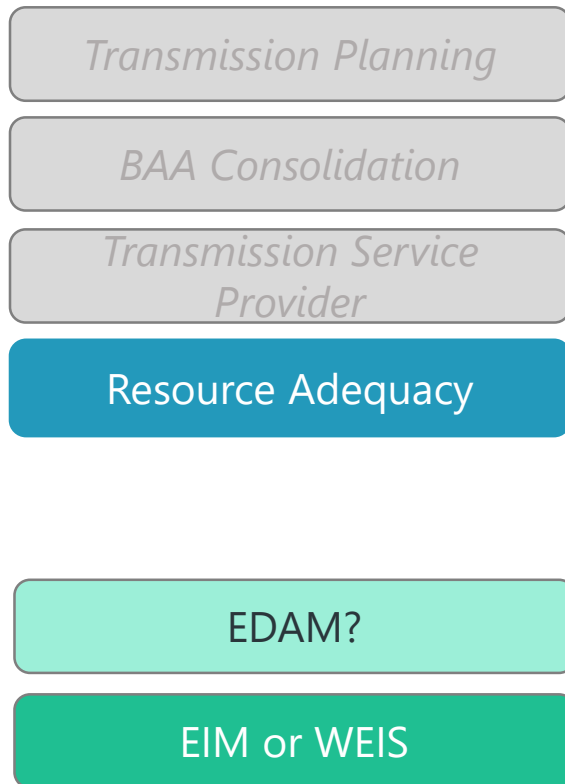

RTO?

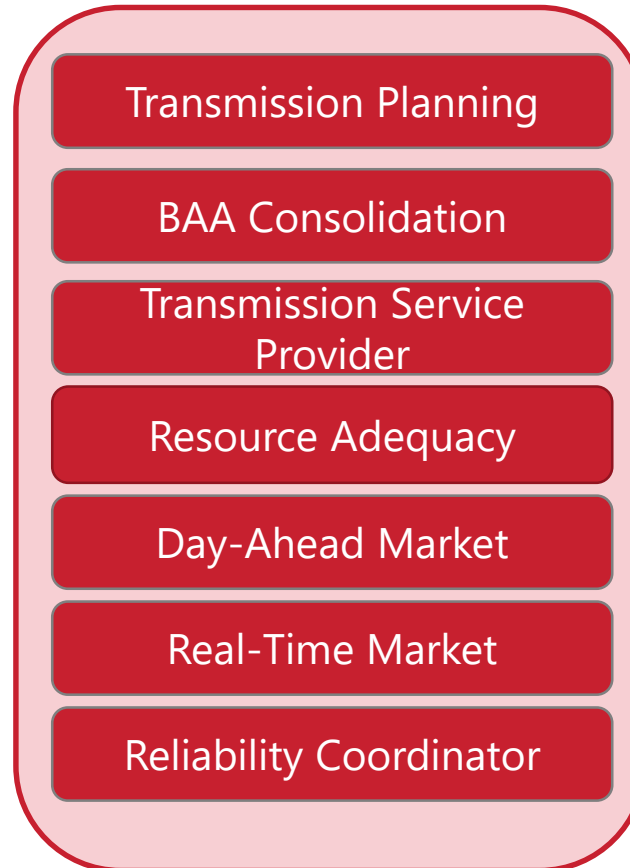

A new option: SPP MARKETS+

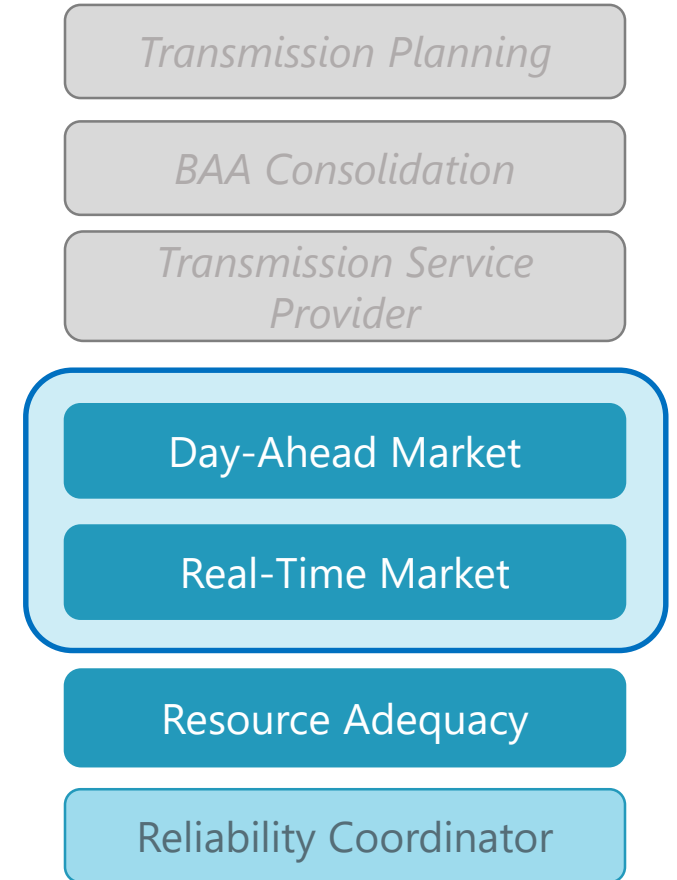

WESTERN INTERCONNECTION RC FOOTPRINT

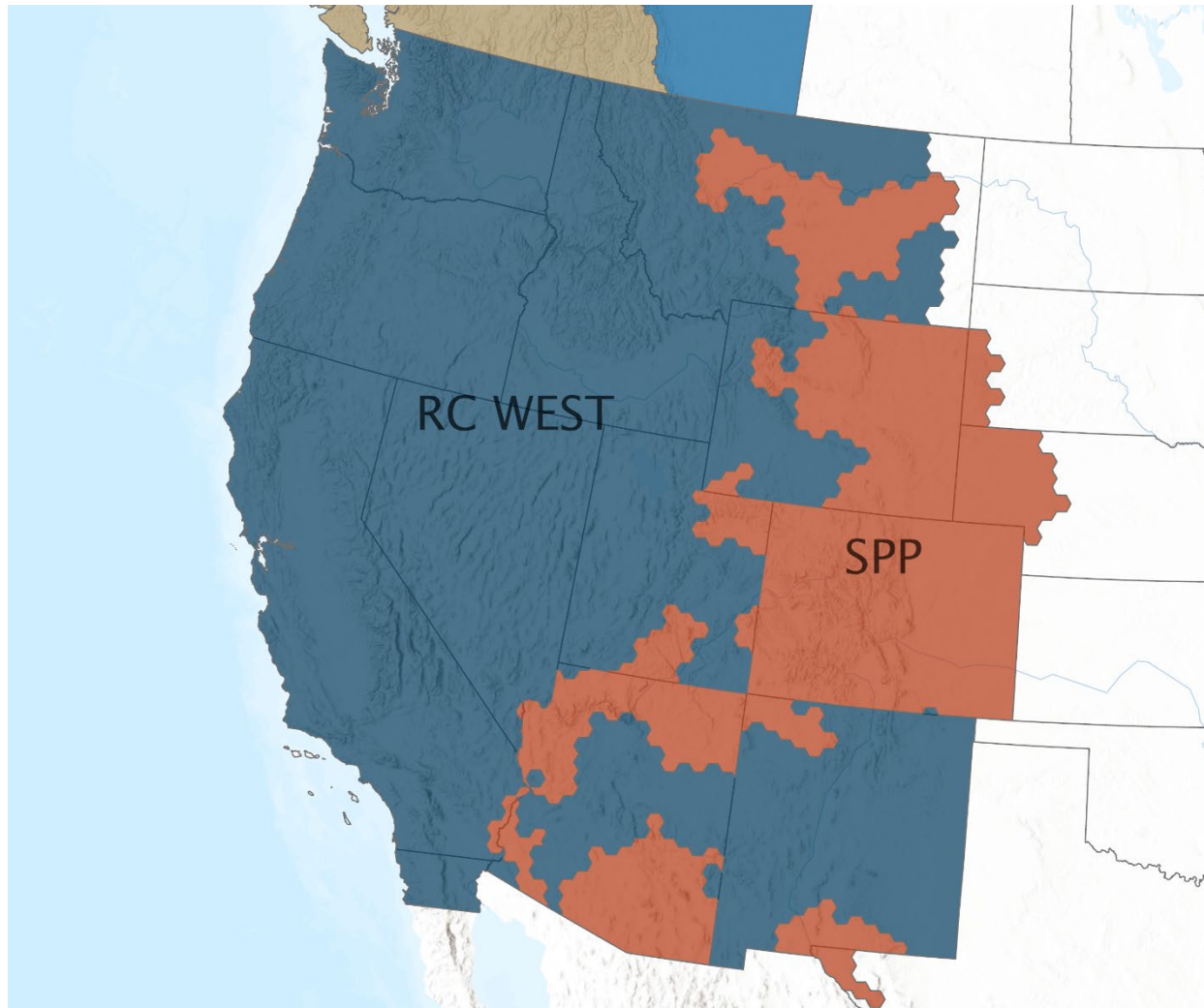

SPP Western RC Customers

Arizona Electric Power Cooperative, Inc.

Black Hills Energy's three electric utilities: Black Hills Power, Inc., Cheyenne Light, Fuel and Power Company, and Black Hills Colorado Electric, Inc.

City of Farmington, NM

Colorado Springs Utilities

El Paso Electric Company

Intermountain Rural Electric Association

Platte River Power Authority

Public Service Company of Colorado (Xcel Energy)

Tri-State Generation and Transmission Association

Tucson Electric Power

Western Area Power Administration (WAPA) Desert Southwest Region, WAPA Rocky Mountain Region, and WAPA Upper Great Plains – West

GridForce Energy Management

OPERATIONAL RELATIONSHIPS RELIABILITY COORDINATOR

- RC Services will be optional
- RC relationships with BAs and TOPs remains unchanged
- Discussions around flow-based operations and congestion management improvements will include both RCs



OPERATIONAL RELATIONSHIPS: WEIS AND EIM

- WEIS will be replaced by Markets+
- Timing issues may drive some overlap, but minimal
- Current EIM participants will have to leave EIM to participate in Markets+
- Markets+ will be informed by EIM and WEIS experiences, but is an autonomous effort

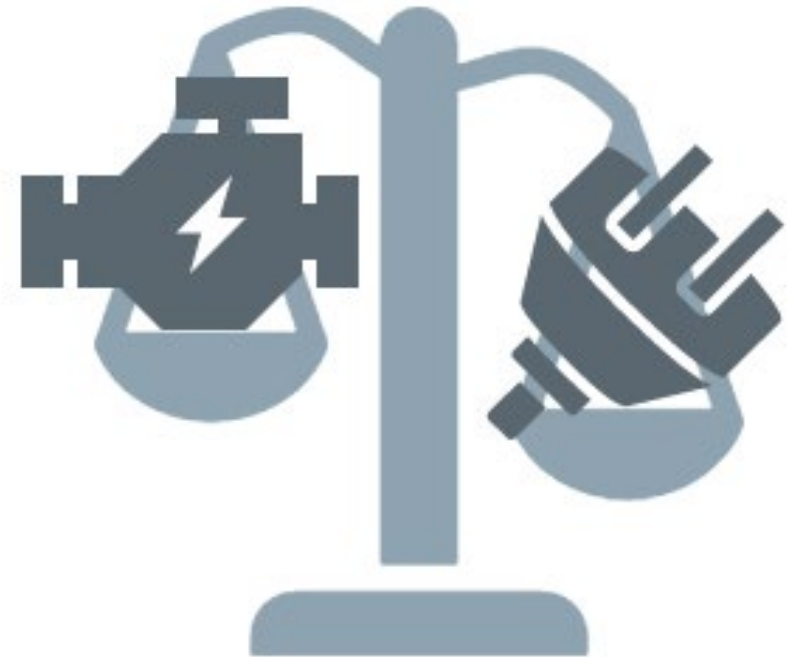

OPERATIONAL RELATIONSHIPS SPP RTO WEST

- **Ideally a single co-optimized unit commitment and dispatch**
 - Phase II discussion
 - Task force will be formed with Markets+ Committee and RTO Market Working Group to develop proposal to enhance market design
 - Keep in mind as initial design and service offering is developed



OPERATIONAL RELATIONSHIPS: WRAP

- Complimentary, not required
- Prioritization of RA resources registered under WRAP
- Explore operationalization of WRAP diversity benefits under Markets+
- Markets+ and WRAP teams to engage and explore options/enhancements going forward

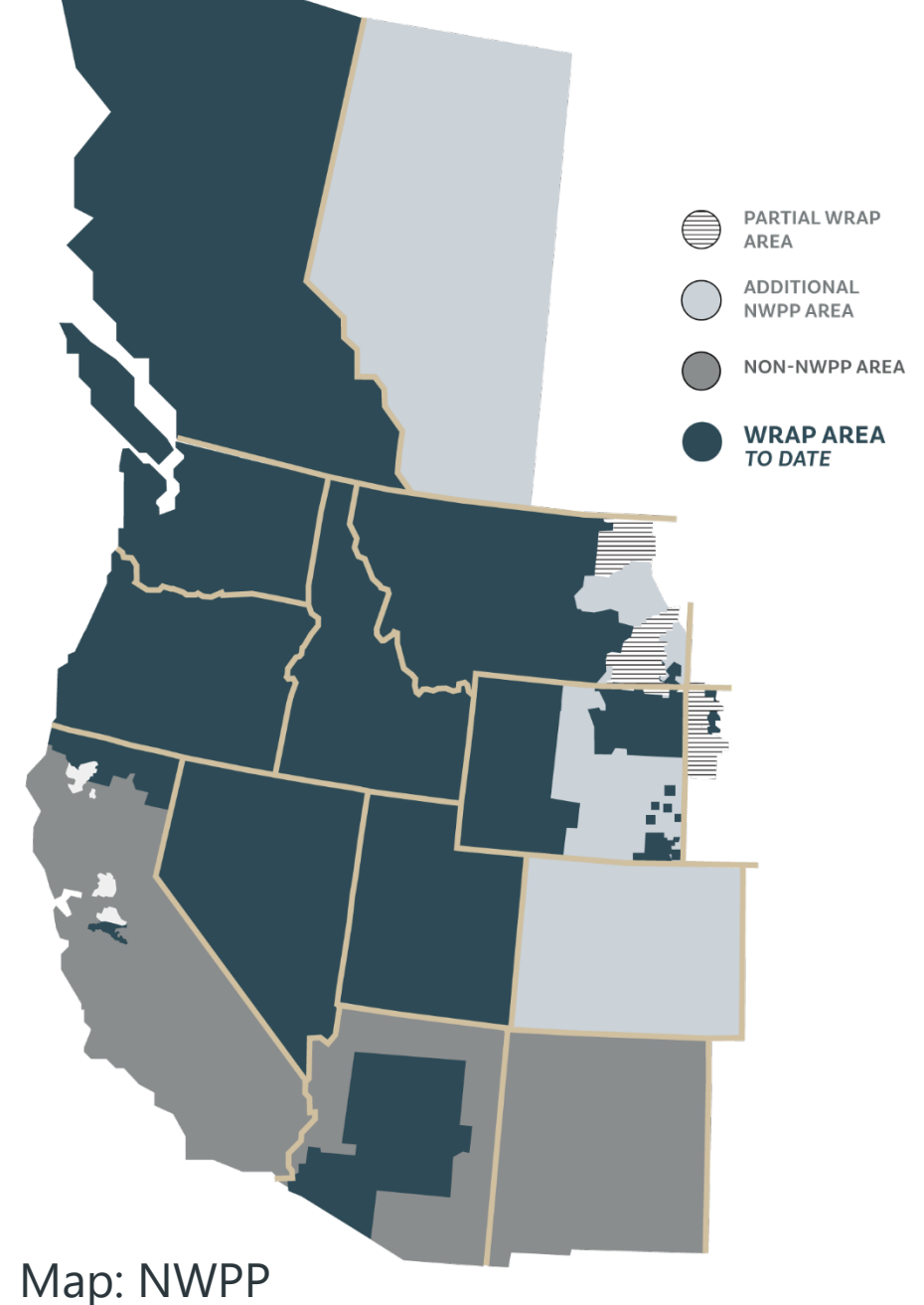

OPERATIONAL RELATIONSHIPS CAISO

- Market-to-market optimized transfers
- Peer-to-peer seams management will ensure fair and equitable outcome for Markets+ participants and CAISO EIM participants
- RC coordination remains as today

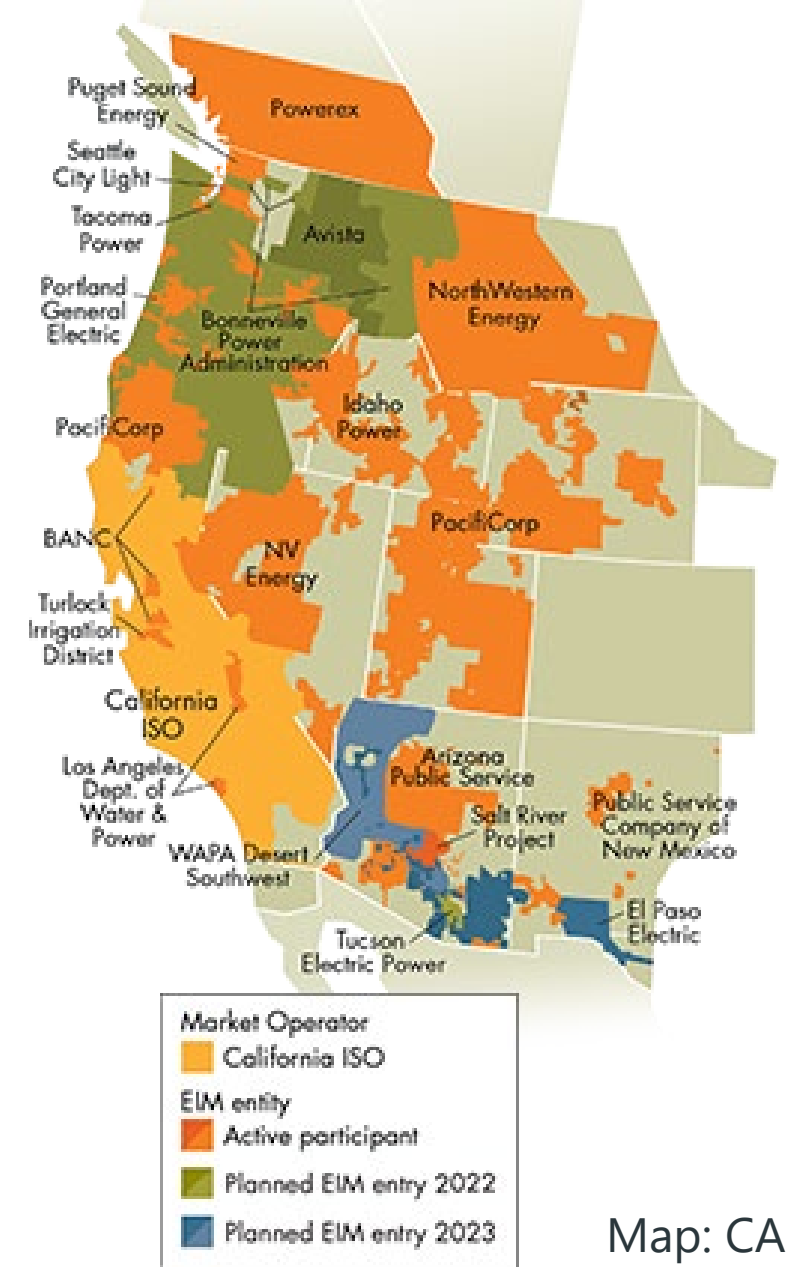

Map: CAISO

WESTERN MARKETS ROADMAP

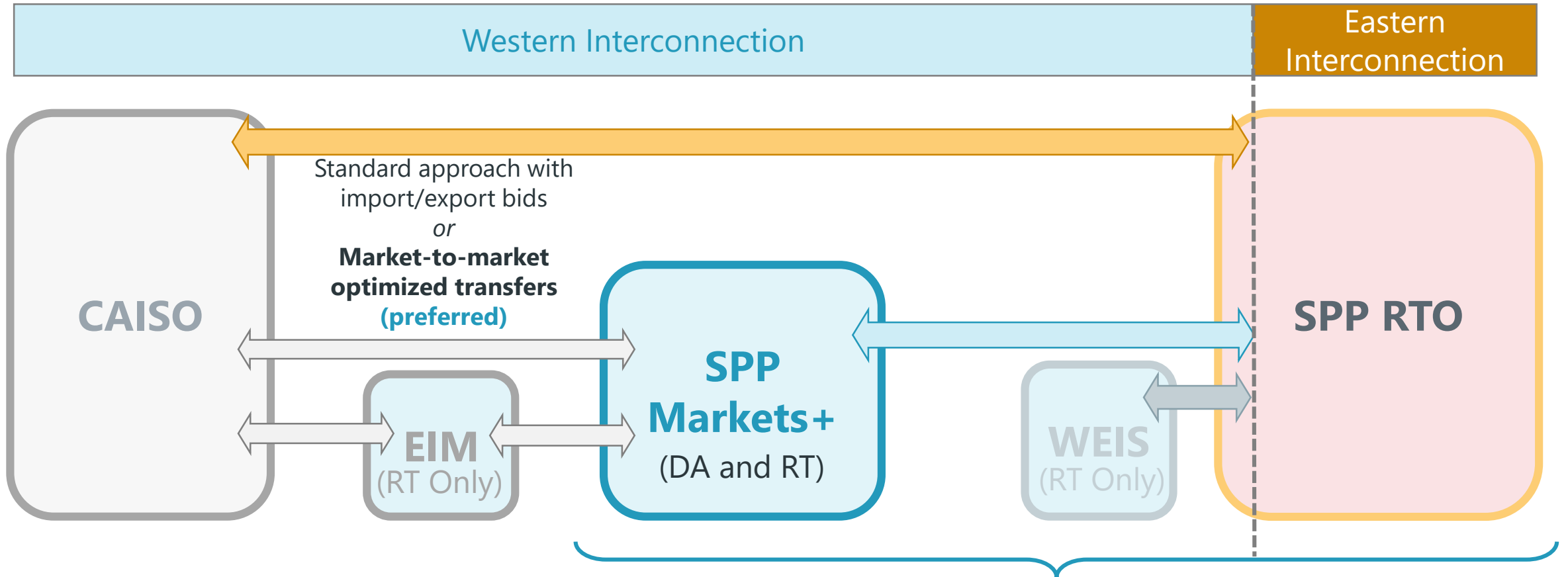

Ideally a single co-optimized unit commitment and dispatch under a robust governance framework with an independent board

NEXT STEPS

BRUCE REW

Step **1**

Seek interested parties
Information gathering



Step **2**

Distribute gathered feedback
Develop timeline and next steps
Develop detailed service offering



Step **3**

Conduct inclusive stakeholder process with committed parties



Step **4**

Obtain Board approval
Seek FERC approval



Step **5**

Launch



We are here

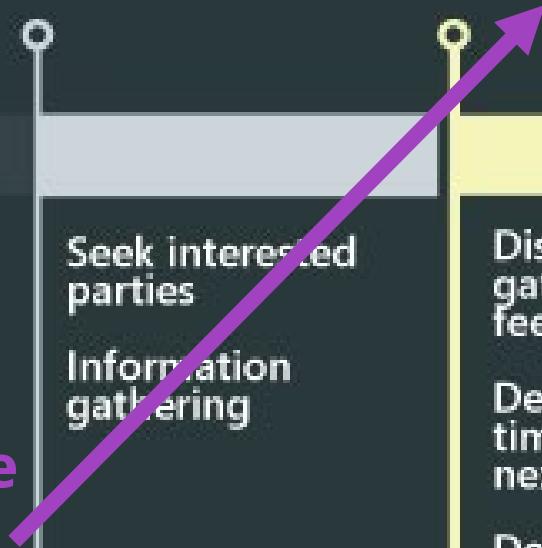

QUESTIONS & DISCUSSION

FUTURE MEETINGS

- February 1 –
 - Market Products and Price Formation Design Team – 8 a.m. P; 9 a.m. M; 10 a.m. C
 - Transmission Availability Design Team - Noon P; 1 p.m. M; 2 p.m. C
- February 2 – Markets+ Developments Update
 - Every fourth Wednesday at 9 a.m. P; 10 a.m. M; 11 a.m. C
- February 14 – Governance Design Team
 - Every other Monday at 10 a.m. P; 11 a.m. M; Noon C
- March 29-30 – In-Person in Portland

Questions or comments?

Contact us at:

marketsplus@spp.org

kfornstrom@spp.org



Southwest Power Pool
**WESTERN
ENERGY
SERVICES**