

MARKETS



GOVERNANCE DESIGN TEAM

March 29, 2022



*Working together to responsibly and economically
keep the lights on today and in the future.*



SouthwestPowerPool



SPPorg



southwest-power-pool



Southwest Power Pool
**WESTERN
ENERGY
SERVICES**

WELCOME AND AGENDA OVERVIEW

KARA FORNSTROM, SPP

BREAKOUT SESSIONS AGENDA

Welcome and Agenda Overview	Kara Fornstrom, SPP
Governance Design Team Review	Lea Fisher, PGP
Panel – Markets+ Governance Perspectives	Sarah Edmonds, Portland
Governance Options: #2A, #2B and #3 <ul style="list-style-type: none">• Schematics• Evaluation Matrices	Stakeholder Leads
Request for Comments <ul style="list-style-type: none">• Comment Template• Comment Period	Kara Fornstrom, SPP
Future Meetings/Schedule	Kara Fornstrom, SPP

GOVERNANCE DESIGN TEAM – BREAKOUT SESSIONS

Tuesday, March 29

	10:00-12:00	Session #1
		10:00-10:15 Welcome and Overview 10:15-10:35 Governance Design Team Review 10:35-10:45 Questions – In-Person and Virtual Participants 10:45-12:00 Panel: Governance Perspectives
	1:00-3:00	Session #2
		Governance Options Schematics Start Building Matrices
	3:15-5:00	Session #3
		Governance Options Continue Building Matrices

Wednesday, March 30

	8:00-9:30	Session #4
		Request for Written Comments Continue Discussion/Prepare for Read-Out

GOVERNANCE DESIGN TEAM REVIEW

LEA FISHER, PGP

GOVERNANCE DESIGN TEAM MEETINGS

- January 31: Operational Relationships
- February 14: Topic Scope and Governance Objectives
- February 28: SPP Board of Directors and Western Contract Services Governance Frameworks
- March 14: Governance Options Introduction

WESTERN MARKETS ROADMAP

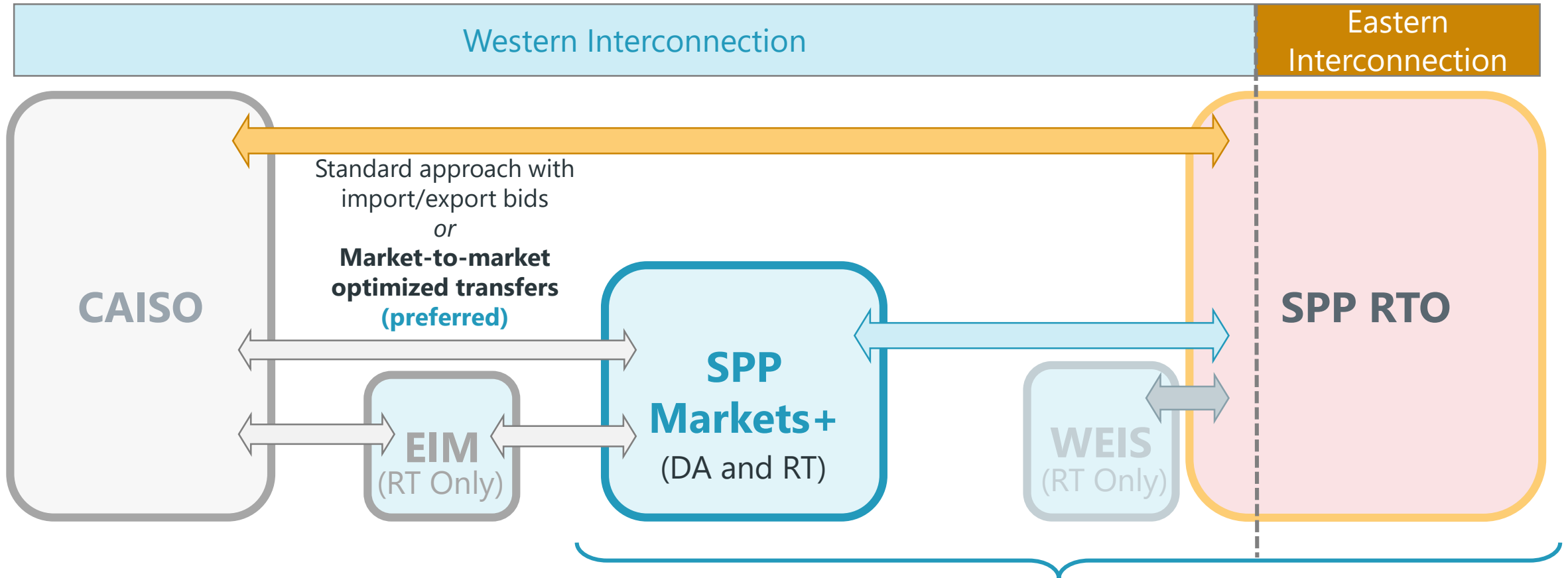

Ideally a single co-optimized unit commitment and dispatch under a robust governance framework with an independent board

GDT TOPIC SCOPE

- Our Issues

- Board of Directors
- Committee Framework
(Participants, Nominating,
Technical, Regulators and
Stakeholders)
- Voting Structures
- Jurisdiction
- Exit Provisions

- Not Our Issues

- Market Monitor
- Green House Gas Tracking
- (Both Issues are separate
design elements that will be
addressed by other teams)

GOVERNANCE OBJECTIVES

- Independent Board of Directors with Skills and Experience Reflective of All Regions, Market Participants and Interests within Its Oversight
- Open, Transparent Stakeholder Process that Balances Diverse Interests
- Board Nominating Process that is Clearly Defined and Geographically/Sector Representative
- Effective Forums for Stakeholders within the Governance Framework

SPP'S BOARD OF DIRECTORS



**Larry
Altenbaumer,
Chairman**
Decatur, IL



**Barbara Sugg
President & CEO**
Little Rock, AR

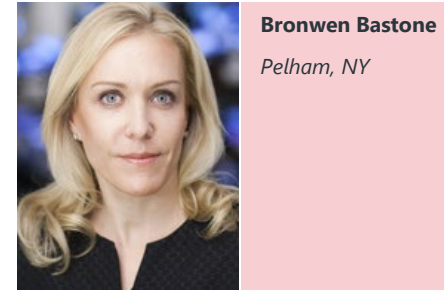

Bronwen Bastone
Pelham, NY

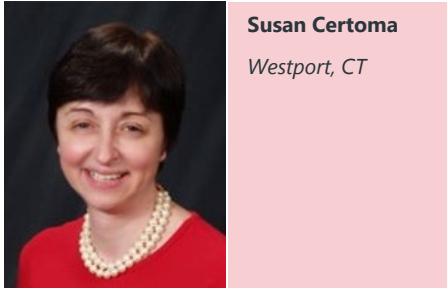

Susan Certoma
Westport, CT



Mark Crisson
Coronado, CA



John Cupparo
West Linn, OR

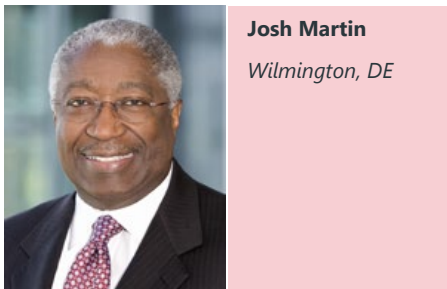

Josh Martin
Wilmington, DE



Elizabeth Moore
Ossining, NY



Ben Trowbridge
Dallas, TX

BOARD OF DIRECTORS



Qualifications: Recent and relevant senior management expertise and experience in one or more of these disciplines:

- Finance
- Accounting
- Electric transmission or generation planning or operation
- Law and regulation
- Commercial markets
- Trading and associated risk management

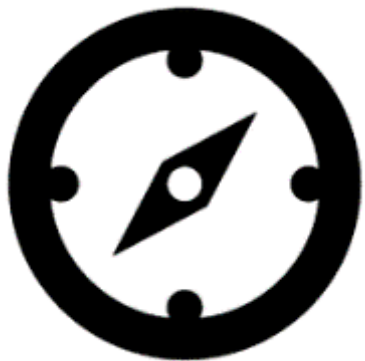

Purpose: The board of directors will manage the general business of SPP pursuant to the SPP bylaws.

CORPORATE GOVERNANCE COMMITTEE REPRESENTATION

Member Type	Member
SPP president – chair	Barbara Sugg, SPP
SPP chair of the board	Larry Altenbaumer
(1) Investor-owned utility	Denise Buffington, Evergy
(1) Cooperative	Mike Wise, Golden Spread
(1) Municipal	Jason Fortik, LES
(1) IPP/Marketer	Betsy Beck, Enel
(1) State power agency	John McClure, NPPD
(1) Alternative power/public Interest	Steve Gaw, APA
(1) Independent transmission	Brett Leopold, ITC
(1) Large/Small retail	Holly Rachel Smith, Walmart
(1) Federal power marketing agency	Lloyd Linke, WAPA
Ex officio member	Josh Martin

SPP'S RELIABILITY COORDINATION STAKEHOLDER GROUPS

Western Reliability Executive Committee (WREC)

Western Reliability Working Group (WRWG)

West Modeling Task
Force

RC Readiness Task Force

Congestion
Management and Seams
Task Force

WEIS GOVERNANCE

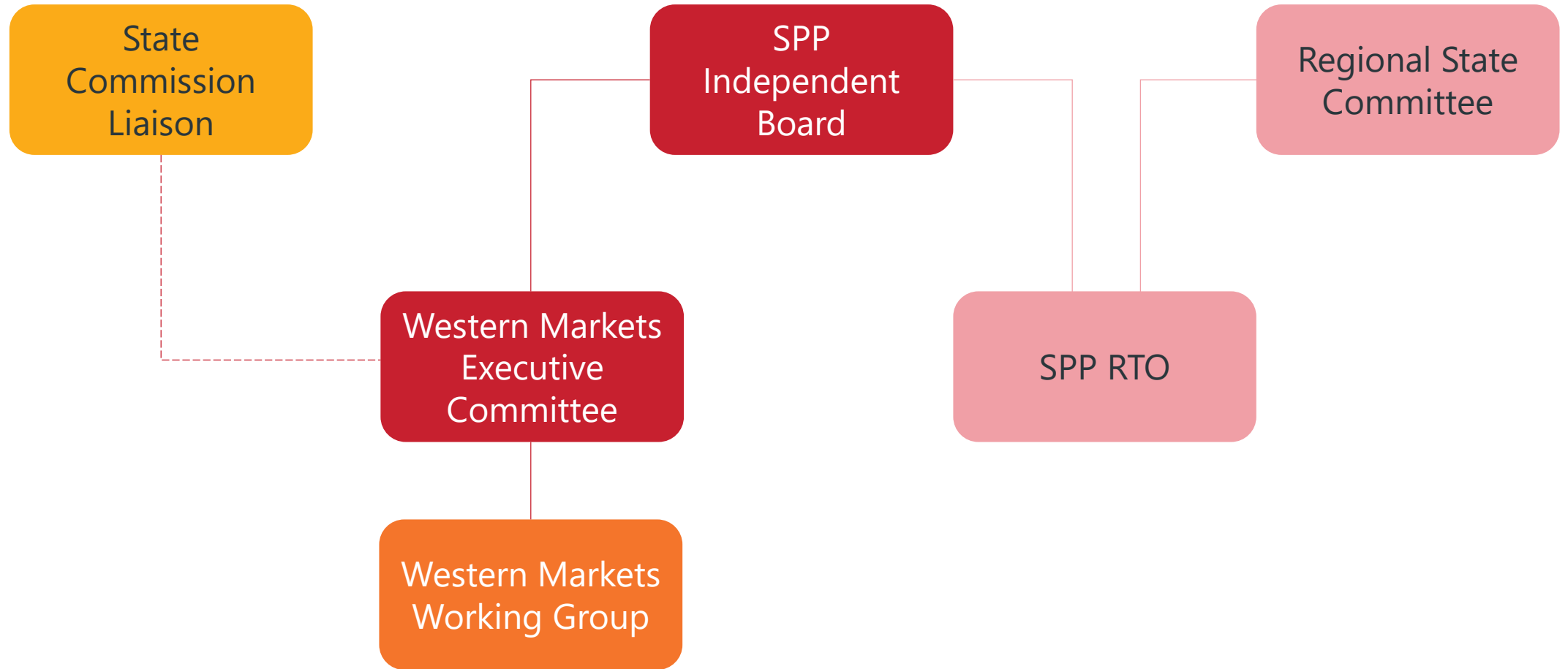

WHAT ARE WE TRYING TO ADDRESS?

Voting rights in Nominating Process for Board of Directors Selection

Effective, but not Overly Burdensome Committee Structure

Cooperative Governance on issues of Joint Concern (Optimization and WRAP)

Autonomy Related to Markets+ Exclusive Issues

Pathway for Markets+ Participants to Integrate into SPP RTO governance as Western RTO footprint expands

MARKETS+ GOVERNANCE OPTIONS

2A

2B

Add 3?

SPP Independent Board

Markets+ Participants Executive Committee (MPEC) – Participant Based

Markets+ Working Group (M2WG) – Sector Based

Future Joint (with RTO) Work Groups

Markets+ State Committee

**Markets+ Independent
Governing Board**

**Nominating Committee
(Sector Based)**

**SPP By-Laws Modification
Board Qualifications?**

**SPP CGC
Add Markets+ Seat?**

PANEL DISCUSSION

GOVERNANCE PERSPECTIVES

GOVERNANCE PERSPECTIVES

MODERATOR: SARAH EDMONDS, PORTLAND

PANELISTS: COMMISSIONER TAMMY CORDOVA, NV

ALY KOSLOW, APS

CARRIE SIMPSON, XCEL ENERGY

SPENCER GRAY, NIPPC

NICOLE HUGHES, RNW

LAUREN TENNEY DENISON, PPC

GOVERNANCE OPTIONS

SCHEMATICS

EVALUATION MATRICES

GOVERNANCE OPTIONS SCHEMATICS

MARKETS+ GOVERNANCE OPTIONS

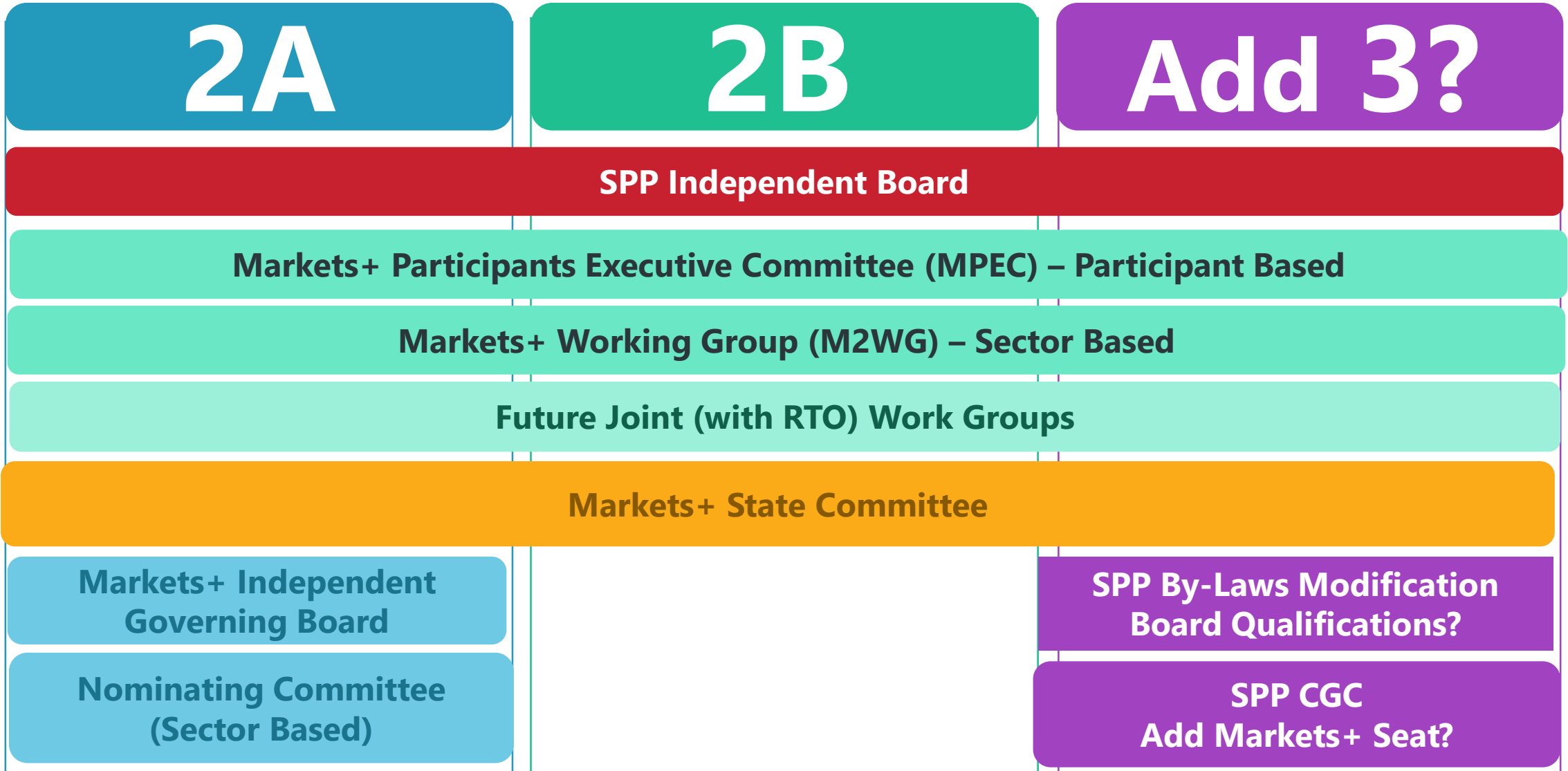

MARKETS+ GOVERNANCE OPTIONS

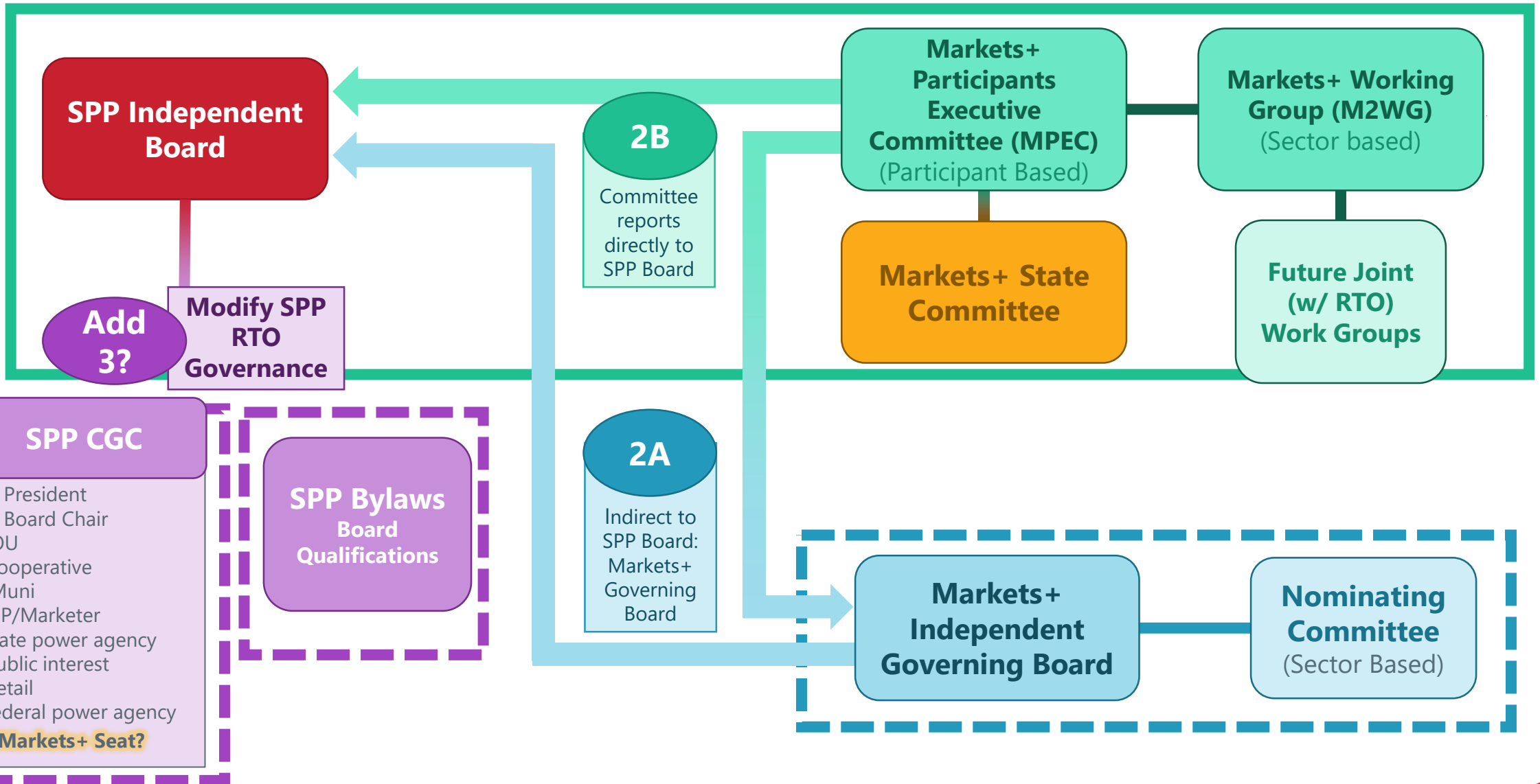

GOVERNANCE OPTIONS EVALUATION MATRICES

2A

	Market Participants Executive Committee	Working Group (sector-based)	Joint Governance Task Forces
--	--	-------------------------------------	-------------------------------------

Authority	Markets+ Tariff, Business Practices		
Purpose	Review, Working Group Proposals, Recommendations to Governing Board		
Composition	Market Participants	Representatives of Market participants and stakeholder sectors	
Qualifications	Sr. mgmt. official w/binding financial decision-making authority		

2A

	Market Participants Executive Committee	Working Group (sector-based)	Joint Governance Task Forces
Leadership (Term/Election) (Resignation/Vacancies)	Committee to determine	Committee to determine	
Meetings (Frequency) (Public/Private)	Public, except when noticed with transparent meeting purpose	Public	
Voting Structure (House/Senate)	House/Senate	Senate	

2B

**Market Participants
Executive Committee**

**Working Group
(sector-based)**

**Joint Governance Task
Forces**

Authority

Purpose

Composition

Qualifications

2B

**Market Participants
Executive Committee**

**Working Group
(sector-based)**

**Joint Governance Task
Forces**

Leadership
(Term/Election)
(Resignation/Vacancies)

Meetings
(Frequency)
(Public/Private)

Voting Structure
(House/Senate)

Markets+ State Committee

Authority/Purpose

Composition/Qualifications

Functions

Markets+ State Committee

Leadership (Term/Election) (Resignation/Vacancies)
Meetings (Frequency) (Public/Private)
Voting Structure
Technical Support (Funding Mechanism)

	Markets+ Governing Board	Gov Board Nominating Cmte
--	---------------------------------	----------------------------------

Authority	Tariff changes, business practices	Oversee process to nominate potential members to the governing board
Purpose		
Composition	5	Representatives of Market participants and stakeholder sectors
Qualifications	Market experience, financial independence from market participants,	

	Markets+ Governing Board	Gov Board Nominating Cmte
--	---------------------------------	----------------------------------

Leadership
(Term/Election)
(Resignation/Vacancies)

Meetings
(Frequency)
(Public/Private)

Voting Structure

Ultimate Entity Participants Executive Committee v. Governing Board

Pro Executive Committee	Lower cost, ease of implementation
Pro Governing Board	Useful mechanism to build trust, independent decision-making, accessibility, transparency
Con Executive Committee	Complicated decisional authority
Con Governing Board	Increased cost and complexity

Potential SPP RTO Governance Modifications

Bylaws BOD Qualifications	Western Interconnection Experience
Corporate Governance Cmte Markets+ Seat	
Others?	

Other Issues

Governance Modification
Process

Governance Review
(Timeframe)
(Process)

3 years with defined triggering conditions

Exit Provisions

Appeals Process

Market participant can appeal any action or inaction of the ultimate authority

REQUEST FOR WRITTEN COMMENTS

COMMENT TEMPLATE

COMMENT DEADLINE: APRIL 20

- PLACEHOLDER FOR COMMENT TEMPLATE
 - (In Development, Will Mirror Matrices)

FUTURE MEETINGS SCHEDULE

KARA FORNSTROM, SPP

FUTURE MEETINGS/SCHEDULE

- April 20: Written Comments Due
- April 25: Governance Design Team Webinar
 - Provide Summary of Written Comments
- April 27: Development Update Webinar
- May 23: Governance Design Team Webinar
 - Present Governance Concept Proposal
- June 1-2: In-Person Meeting - Denver